



1600 33rd Street, Unit 102
Orlando, Florida 32839
T. 407.872.2223 F. 407.872.8644
Email: info@gobencs.com

Exhibitor Service Manual

**American Nuclear Society
Utility Working Conference Expo**

August 6-9, 2017

**Omni Amelia Island Plantation Resort
Amelia Island, FL**



1600 33rd Street, Unit 102
Orlando, Florida 32839
T. 407.872.2223 F. 407.872.8644
Email: info@gobencs.com

Exhibitor Manual Contents

| Page | Content |
|---------|--|
| 1 | Show Cover Page |
| 2 | Manual Contents |
| 3 | Online Ordering Info |
| 4 | Exhibitor Compass - Information |
| 5 | Service Contractor Info & Contacts |
| 6 | General Information |
| 7 | Payment Terms & Conditions |
| 8 | Billing Authorization |
| 9 | EAC (Exhibitor Appointed Contractor) |
| 10 | Furniture & Accessories |
| 11 | Credenza/Computer Kiosks |
| 12 | Custom Rental Units |
| 13 | Price List- Credenza/Computer Kiosk/Custom Units |
| 14 | Carpet & Padding |
| 15 | Cleaning Services |
| 16 | Signs & Graphics |
| 17 | Floral Pictures |
| 18 | Floral Order Form |
| 19 | Audio |
| 20 | Labor & Forklift Services |
| 21 | Material Handling Information |
| 22 | Material Handling Information (Continued) |
| 23 | Material Handling Service & Rates |
| 24 | Exhibitor Shipping Information |
| 25 | Advance Warehouse Shipping Label |
| 26 | Show Site Delivery Shipping Label |
| 27 | Move Out Information |
| 28-29 | UPS Freight |
| 30 - 32 | Electrical & Internet |
| | |



Official Exhibitor Services Supplier for ANS

You can log in if you prefer to order online!

How do I log in?

Once your show is available online, you will receive an automated email that includes your personalized show code. All information within the email will allow you to retrieve show documents, order online, and submit changes to your order.

If you do not receive a show code and wish to order online, please contact us at (407) 872-2223 or email orders@gobencs.com

Please be aware that you will need to create a new account when you place your first order. Don't worry - it's quick and easy and will help us serve you better.

Please note Gobencs Fees/Charges:

Goben Convention Services assesses fees for changes and cancellation of your show order. Please review the following.

* After orders are submitted online, you will have up to 24 hours to add/remove items from your order without penalty. After order processes, a 5% administrative fee is charged for all changes/refunds.

* Due to preparations and equipment readiness, orders that are cancelled 1 week before the move - in date are assessed a 50% cancellation fee.

* For orders cancelled on day of move - in or after delivery to booth, cancellation fee is 100%.

Questions?

Contact Customer Service at (407) 872-2223 or email orders@gobencs.com



1600 33rd Street, Unit 102
Orlando, Florida 32839
T. 407.872.2223 F. 407.872.8644
Email: info@gobencs.com

exhibitor compass

EXHIBIT MOVE IN

No Children under 18 are allowed on the show floor during set up & teardown * No Exceptions*

| Day | Date | Time |
|----------|------------------------|-----------------|
| Saturday | August 5 th | 4:00pm – 6:00pm |
| Sunday | August 6 th | 8:00am – 4:00pm |

EXHIBITOR HOURS

| Day | Date | Time |
|-----------|------------------------|-----------------|
| Sunday | August 6 th | 6:00pm – 8:00pm |
| Monday | August 7 th | 7:30am – 4:30pm |
| Tuesday | August 8 th | 7:30am – 7:00pm |
| Wednesday | August 9 th | 7:00am – 9:00am |

EXHIBIT MOVE OUT

Any Exhibitor who chooses to teardown early without preapproval from ANS will be subject to penalties.

| Day | Date | Time |
|-----------|------------------------|--------|
| Wednesday | August 9 th | 9:00am |

DISMANTLE | CARRIER CHECK-IN

To ensure that all exhibitor materials are removed from the exhibit facility by the exhibitor move-out deadline, please have your carriers check in by:

| Day | Date | Time |
|-----------|------------------------|---------|
| Wednesday | August 9 th | 12 noon |

RE-ROUTE TIME

If your carrier has not checked in your freight will be re-routed with the show carrier at:

| Day | Date | Time |
|-----------|------------------------|-------|
| Wednesday | August 9 th | 12:01 |

DISMANTLE | MOVE OUT DEADLINE

All exhibitor materials must be removed from the exhibit facility by:

| Day | Date | Time |
|-----------|------------------------|--------|
| Wednesday | August 9 th | 1:00pm |

See Carrier Check-in time above to ensure that you plan according to the dismantle/move out deadline. Schedules listed above are subject to change by Show Management.

VENUE INFORMATION

Omni Amelia Island Plantation Resort
c/o Goblen CS
39 Beach Lagoon Rd
Amelia Island, FL 32034
Phone: 904-432-1730

BOOTH INFORMATION

Standard Booth Size – 8' deep x 10' wide
- Pipe & Drape –

| | |
|-------------|--------------|
| Back Wall | Blue & White |
| Side walls | Blue |
| Table Skirt | Show colors |

| Included Booth Package Equipment | Quantity |
|-------------------------------------|----------|
| 6'x30" skirted table in show colors | 1 |
| booth identification sign | 1 |
| Wastebasket with Liner* | 1 |
| Padded Chairs | 2 |
| 10 amp electrical connection | 1 |

If you require electrical above the 10amps provided with your booth package, please order accordingly.

There are no substitutions with included booth package equipment Your preferred alternatives may be ordered through the exhibitor manual.

*Wastebasket with liner does not include emptying of trash or booth vacuuming. Cleaning services if required must be ordered through the exhibitor manual.

IMPORTANT DATES

| | Mark your Calendar |
|--|--|
| Shipments can start arriving at Advance Warehouse | Fri, July 7 th |
| Discount deadline orders received with confirmed payment. | Fri, July 21 st |
| Last Day for Shipment to arrive at warehouse w/o surcharge | Fri, July 28 th |
| Last day for shipments to arrive at warehouse | Fri, Aug 4 th |
| Shipments can start arriving at Show Site | Sat, Aug 5 th <i>STRICTLY ENFORCED</i> |
| Move Out | Wed, Aug 9 th @ 9:00am |
| Driver check in for move out | Wed, Aug 9 th @ 12 noon |
| Re-Route freight | Wed, Aug 9 th @ 12:01 |

IMPORTANT INFORMATION

Schedules listed above are subject to change by show management Should any freight/materials be left at the exhibit venue after the Dismantle & Move Out Deadline, GCS reserves the right to re-route all freight/materials via the preferred carrier. Any and all shipping & handling charges by the show carrier will be billed and paid by the exhibitor. GCS is not responsible for those shipping charges for freight/materials left after the Move Out Deadline.



1600 33rd Street, Unit 102
Orlando, Florida 32839
T. 407.872.2223 F. 407.872.8644
Email: info@gobencs.com

service contractor information & contacts

QUICK CONTACTS

REGISTRATION – BOOTH ASSIGNMENT

Laurie Barnett | AM Nuclear Society
T. 708-579-8287 | F. 708-579-8234
Email: meetings@ans.org

SHIPPING – STORAGE – FURNITURE - PLANTS SIGNS – LABOR – CARPET – CLEANING

Stephanie Placeres | Goben Convention Services
T. 407-872-2223 | F. 407-872-8644
Email: stephanie@gobencs.com

CUSTOM FURNITURE

Stephanie Placeres | Goben Convention Services
T. 407-872-2223 | F. 407-872-8644
Email: stephanie@gobencs.com

AUDIO VISUAL

Myra Murray | Goben Convention Services
T. 407-872-2223 | F. 407-872-8644
Email: myra@gobencs.com

ELECTRICAL

Encore
T. 904-277-5982 | F. 904-277-5176
Email: richard.wade@encore-us.com

INTERNET

Encore
T. 904-277-5982 | F. 904-277-5176
Email: richard.wade@encore-us.com

UPS Freight

Preferred Show Carrier
Customer Service Trade Show Dept.
T. 800-988-9889

SHIPPING INFORMATION

ADVANCE WAREHOUSE ADDRESS

Shipping Address & Preferred Label Format

****Exhibiting Company Name****

****Exhibiting Booth #****

AM Nuclear Society / UWC

Goben Convention Services

DNL Logistics c/o UPS Freight

14476 Duval Place West, #501 (last warehouse on right)

Jacksonville, FL 32218

Warehouse materials are accepted at the warehouse

Monday – Friday | 8:30am – 4:00pm

Goben Convention Services will start accepting crates, boxes
and skidded materials beginning:

July 7th

Starting at 9:00am

SHOW SITE ADDRESS

Shipping Address & Preferred Label Format

****Exhibiting Company Name****

****Exhibiting Booth #****

AM Nuclear Society / UWC

C/O Goben Convention Services

Omni Amelia Island Plantation Resort

39 Beach Lagoon Rd

Amelia Island, FL 32034

Shipments arriving before this date and time may be refused
by the facility. Any charges incurred for early freight
accepted by the facility are the responsibility of the
exhibitor.

Goben Convention Services will start accepting crates, boxes
and skidded materials beginning:

Sat, Aug 5th

Starting at 9:00am

STRICTLY ENFORCED!

*PLEASE DO NOT SEND FREIGHT TO THE HOTEL PRIOR TO
AUG 5th. IF YOUR FREIGHT ARRIVES BEFORE THIS DATE
THERE IS A CHANCE IT MAY BE REFUSED. THE HOTEL DOES
NOT HAVE THE STORAGE OR MANPOWER TO HANDLE
TRADE SHOW FREIGHT. IF THE HOTEL DOES ACCEPT YOUR
FREIGHT THEN YOU WILL BE CHARGED A HANDLING FEE BY
THE HOTEL AND THEN BY GOBEN CS.*

PLEASE SEE "MATERIAL HANDLING" ON NEXT PAGE.



1600 33rd Street, Unit 102
Orlando, Florida 32839
T. 407.872.2223 F. 407.872.8644
Email: info@gobencs.com

general information

Material Handling

Goben Convention Services has been contracted to handle this event which includes all drayage whether it is received at the warehouse or the show site. As the **"EXCLUSIVE"** material handling contractor we will handle **ALL** freight shipments in and out of the ballroom.

Warehouse receiving hours are 8:30am – 4:00pm, Monday – Friday.
You may start sending freight to the advance warehouse 30 days prior to the start of show at no additional charge.

Drayage is defined as the delivery of freight from the advanced warehouse, loading dock or hotel storage room to your booth space and from the booth space to the loading dock at the close of the show.

Please note if you send freight to the show venue before the published date listed in this exhibitor manual your freight will either be **REFUSED** or you will be charged handling & storage fees from the hotel. The freight will then be turned over to Goben CS for delivery to the exhibit hall and you will **ALSO** be charged material handling fees, **even if you are a guest of the hotel.**

Please note: Mislabeled packages have the potential of being refused at show site. Please remember to include ANS c/o Goben CS on all packages AND remove all old labels from packaging.

Preferred Freight Carrier

Listed below is the information for the official freight carrier of Goben Convention Services.



800.988.9889

www.UPSFreight.com

UPS FORM LOCATED AT THE BACK OF THIS MANUAL
MENTION SHOW NAME FOR DISCOUNTED SHOW RATES

International Shipments

Should your display require clearance by a United States Customs Office you must make arrangements with a custom broker. Goben Convention Services cannot clear the shipment on behalf of the shipper.

Equipment Use

Goben Convention Services does not lend out any equipment to exhibitors. If you require help for the setup of your booth, you must fill out the provided labor forms included in this service kit. Please note that request for labor services on show-site is not guaranteed. If you require assistance bringing items to your booth, please note that you are subject to material handling fees and labor charges at the current prevailing cost.

Labor

Labor is for installation & dismantling of displays, Please refer to the Labor forms included in this manual to order services. TIP: Order early and in advance to guarantee labor services. Exhibitors may setup and dismantle their own displays provided they use their own company employees to do so.

Exhibitor Appointed Contractors

If you are utilizing an outside contractor, Goben Convention Services must be informed two weeks prior to setup. A valid "certificate of insurance" must be submitted to Goben Convention Services by the date illustrated on the Exhibitor Appointed Contractor Notification form included in the exhibitor service kit. Notifications received after the date may not receive approval. Failure to provide Goben Convention Services a certificate of insurance will result in labor hire from the Goben Convention Services staff. The non-official contractor will be able to provide supervision only. Exhibitor Appointed Contractors who subcontract for services other than general contracting are also considered non-official contractors and must follow set procedures; this includes florists, audio visual and computer rental firms.

Security

Exhibitors are responsible for safeguarding their goods, materials, equipment and exhibits at all times. Goben Convention Services is not responsible for any unattended items left in the tradeshow facility or assigned booths. **All booth personnel will need credentials, which will allow access onto the trade show floor. Security will be checking badges & manning the entrance/exits of the Expo at all times.**

Safety

Standing on chairs, tables or any rental furnishings is prohibited. Goben Convention Services is not responsible for injuries or falls caused by improper use of furnishings. Should a folding chair not accommodate you, please advise us and we will substitute that chair with a current in-stock side chair upon availability.

If assistance is required in the installation/dismantle of your booth, please order labor using the enclosed labor form and the necessary ladders, and tools that need to be provided.

No Children under 18 are allowed on the show floor during set up & teardown * No Exceptions*

Acceptance of General Information

By signing off on any services/order provided by Goben Convention Services automatically indicates that you, the client/exhibitor, are in acceptance and agreement of our general information section. Any questions about the general information section for Goben Convention Services, please contact us at 407-872-2223 or at info@gobencs.com.



1600 33rd Street, Unit 102
Orlando, Florida 32839
T. 407.872.2223 F. 407.872.8644
Email: info@gobencs.com

payment terms & conditions

Payments

Goben CS requires that you provide a credit Card Authorization with your initial order. For your convenience we will use this authorization to charge your account for services, which may not have been covered by your initial order. Purchase Orders are not considered payment. All orders received without the method of payment form will be charged standard rates.

For the convenience of all, we ask that all disputes be questioned prior to show close via calling the office or visiting the on-site service desk for billing questions and concerns. If an exhibitor fails to pay their invoice prior to close of show, the charges will automatically be applied to the credit card on file.

Method of Payment

We accept Master card, Visa, American Express & checks (US Bank)

Fees

A \$30.00 charge will apply for charges associated with the following:

~ *Insufficient Funds*

~ *Charge back fees on credit cards*

This fee will be added to your final invoice.

Wire Transfers

If you are using wire-transfers for payment, please add an additional amount of \$55.00 to the wired amount. This \$55.00 is a processing fee for the wire transfer assessed by Goben Convention Services. Please contact 407.872.2223 for wire transfer information.

International Exhibitors

We require 100% payment of advance and standard orders. Any orders or services placed with Goben Convention Services on show site, those services must be paid in full. Payment must be made via check in United States fund drawn from a United States Bank.

Should your display require clearance by a United States Customs Office you must make arrangements with a custom broker. Goben Convention Services cannot clear the shipment on behalf of the shipper.

Cancellations

Orders cancelled after the discount deadline date will be charged 50% cancellation charge.

Orders cancelled after decorator move-in begins are subject to a 100% cancellation charge.

A one-hour "per person" charge will be applied for all labor orders that are not cancelled in writing at least 24 hours prior to the scheduled start time.

Miscellaneous

Rental Items not ordered but found in the booth space will be invoiced at "standard" rates.

Tax Exemption Status

If you claim tax exempt status, you must provide us with a copy of your tax Exempt Certificate issued by a federal government or state in which the event is taking place, simultaneously with the placement of your initial order, otherwise tax will appear on your invoice. No credits for sales taxes will be issued after billing is complete.

Tax Rate

All rental items are subject to applicable taxes.

Tax rate for Amelia Island, FL will be 7%

Third Party Billing

Each exhibiting firm is ultimately responsible for all charges incurred on its behalf. Goben Convention Services reserves the right to institute a collection action against the exhibitor if the third party does not pay.

Credits

It is the responsibility of the exhibitor/client to check the accuracy of your invoices and report any concerns of your ordered services prior to show close. All concerns reported prior to show close will be considered for credits to your account with Goben Convention Services.

Rentals

All materials and equipment are on a rental basis for the duration of the show and remain the property of Goben Convention Services. All rentals include delivery, installation and removal from your booth.

Unpaid Balances

Should there be any unpaid balance after the close of show; terms will be net, due and payable upon receipt of invoice. Effective 30 days after invoice date, any unpaid balance will bear a finance charge at the lesser of the maximum rate allowed by applicable law, or 1.5% per month, which is an annual percentage rate of 18% and future orders will be on a pre-payment basis. If the finance charge hereunder exceeds the maximum rate allowed by applicable law, the finance charge shall automatically be reduced to the maximum rate allowed, and excess finance charge received by Goben Convention Services shall be either applied to reduce the principal unpaid balance or refunded to the payer. Payment terms and conditions shall be governed and construed in accordance with the laws of the state of Florida.

Acceptance of Payment Terms & Conditions

By signing off on any services/order provided by Goben Convention Services automatically indicates that you, the client/exhibitor, are in acceptance and agreement of our Payment Terms and Conditions. Any questions about the Payment Terms and Conditions for Goben Convention Services, please contact us at 407.872.2223 or at info@gobencs.com.



1600 33rd Street, Unit 102
 Orlando, Florida 32839
 T. 407.872.2223 F. 407.872.8644
 Email: orders@gobencs.com

billing authorization

| EXHIBITING COMPANY INFORMATION | | | |
|------------------------------------|--|-------------|--|
| Exhibiting Company Name: | | | |
| Booth# | | | |
| Exhibiting Company Address: | | | |
| City/State/Zip: | | | |
| Phone : | | Fax: | |
| E-mail: | | | |

| Payment Options | |
|-----------------|-----------------------------------|
| | Select One |
| | Credit Card |
| | Company Check |
| | Cash |
| | Wire Transfers (call for details) |

Goben Convention Services gladly accepts Cash, Company Check, Credit Card and Wire Transfers.

| Billing Address (If different from above) | |
|---|--|
| Address: | |
| City/State/Zip: | |
| Phone: | |
| Fax: | |
| E-mail: | |

| EXHIBITOR CREDIT CARD AUTHORIZATION |
|-------------------------------------|
|-------------------------------------|

For your convenience, we will use this credit card billing authorization to charge your credit card account for your advance, standard and on-site orders, along with any additional amounts incurred as a result of show site orders placed by your exhibit booth representative.

VISA

 MASTERCARD

 AMERICAN EXPRESS

| | | | |
|---|--|--|--|
| Card Holder Name: | | | |
| Credit Card Number: | | Expiration Date: | |
| Goben Convention Services is committed to keeping your provided financial information safe and secure | | Validation Code: <small>(3 or 4 Digit Code on the back or bottom of the Credit Card)</small> | |
| Printed Name: | | | |
| Signature: | | Date: | |

By signing, you acknowledge you have read, understand and agree to all the terms in the payment terms and conditions and have advised our organization of any questions on purchases of services and materials. You also acknowledge and have read, understand and agree to the general information sections of the exhibitor manual. The payment terms & conditions and general information are included in this exhibitor manual.

Third Party Billing
 Please call the office at 407-872-2223 for a third party billing authorization form



1600 33rd Street, Unit 102
 Orlando, Florida 32839
 T. 407.872.2223 F. 407.872.8644
 Email: orders@gobencs.com

EAC - exhibitor appointed contractor

In the event you are planning to utilize a firm other than GOBEN CONVENTION SERVICES, the Exhibitor must complete and acknowledge the requirements and procedures to have an Exhibitor Appointed Contractor/EAC on-site.

This notification must be turned in with Certificate of insurance by the date of:

July 21st 2017

| EXHIBITING COMPANY INFORMATION ~ Please print clearly ~ | |
|--|--|
| Exhibiting Company: | |
| Booth #: | |
| Contact Telephone: | |
| Exhibitor Contact Name: | |
| Exhibiting Firm's Officers Signature: | |

| EXHIBITOR APPOINTED CONTRACTOR / EAC "Non-Official Contractor" ~ Please print clearly ~ | |
|---|--|
| Contractor Company Name: | |
| Contact Telephone: | |
| Contact E-mail: | |

With this form a CERTIFICATE OF INSURANCE showing General Liability and Workman's Compensation valid in the state where the show is being held, naming GOBEN CONVENTION SERVICES, as an additional insured and certificate holder. The CERTIFICATE OF INSURANCE MUST be submitted together with this notification. We will not accept a CERTIFICATE OF INSURANCE on-site on the show floor. This is due by the date listed above, on the top of this page.

The exposition floor, aisles, loading docks, services and storage areas will be under the control of Goben Convention Services. The Exhibitor Appointed Contractor (EAC) / Non-Official Contractor must coordinate all of its activities with Goben Convention Services.

The Exhibitor Appointed Contractor (EAC) / Non-Official Contractor will be responsible for all reasonable costs related to its operation, including overtime pay for stewards, restoration of exhibit space to its initial condition, freight handling charges, etc. It will be the responsibility of the Exhibitor Appointed Contractor (EAC) / Non-Official Contractor to remove from the floor all tape installed, any bulk trash from the booth floor and from the exhibit hall (such as skids or crates) will be invoiced accordingly by Goben Convention Services.

These requirements will be strictly enforced. In the event that these rules are not adhered to, labor must be hired through Goben Convention Services.

This form along with your Certificate of Insurance can be submitted via these options:

| | | |
|--------------|---|--------------------|
| FAX | MAIL | E-MAIL |
| 407.872.8644 | Goben Convention Services 1600 33 rd Street, Unit 102 Orlando, Florida 32839 | orders@gobencs.com |



1600 33rd Street, Unit 102
 Orlando, Florida 32839
 T. 407.872.2223 F 407.872.8644
 Email: orders@gobencs.com

furniture & accessories

| | |
|---------------------|--|
| Exhibiting Company: | |
| Booth: | |

| SEATING | | | | |
|---------|---------------------------------|----------|----------|-------|
| Qty | Description | Discount | Standard | Total |
| | Side Chair | 40.00 | 50.00 | |
| | Padded Folding Chair | 40.00 | 50.00 | |
| | Upholstered Arm Chair | 50.00 | 62.00 | |
| | Upholstered Counter Stool | 54.00 | 67.00 | |
| | Secretary chairs | 50.00 | 62.00 | |
| | Herman Millar Aeron Posture Fit | 300.00 | 375.00 | |

| ACCESSORIES | | | | |
|-------------|-------------------------------|------------------|----------|-------|
| Qty | Description | Discount | Standard | Total |
| | Chrome Stanchion | 28.00 | 35.00 | |
| | Velvet Rope (gray/red) | 15.00 | 19.00 | |
| | Wastebasket | 12.00 | 15.00 | |
| | Sign Holder 22"x28" | 42.00 | 53.00 | |
| | Chrome Tripod Easel | 28.00 | 35.00 | |
| | Literature Rack | 90.00 | 88.00 | |
| | Bag Rack | 37.00 | 46.00 | |
| | Fish Bowl | 15.00 | 19.00 | |
| | Raffle Drum | 85.00 | 106.00 | |
| | Refrigerator 34" | 125.00 | 156.00 | |
| | Filing Cabinet (lockable) 28" | 70.00 | 87.00 | |
| | Glass Display Case | Call for Pricing | | |
| | Podium | Call for Pricing | | |
| | Grid Wall 2'x8' sections | 80.00 | 100.00 | |
| | Poster Board 4'x6' | 97.00 | 122.00 | |
| | Poster Board 4'x8' | 115.00 | 144.00 | |

| SPECIAL BOOTH DRAPE | | | | |
|---------------------|-------------------------|----------|----------|-------|
| Qty | Description | Discount | Standard | Total |
| | White Vinyl Table Cover | 12.00 | 15.00 | |
| | Table Skirt 30" | 55.00 | 69.00 | |
| | Table Skirt 42" | 60.00 | 75.00 | |
| | Spandex Cocktail cover | 59.00 | 74.00 | |
| | 8' Masking Drape | 10.00/lf | 12.00/lf | |
| | 3' Masking Drape | 7.00/lf | 9.00/lf | |
| | 8' Upright | 9.00 | 11.00 | |
| | 3' Upright | 9.00 | 11.00 | |
| | Cross Beam | 9.00 | 11.00 | |

When ordering, please select color below

| | | | | |
|-------|------|----------|-------|-------|
| Black | Blue | Burgundy | Gold | Peach |
| Gray | Red | Teal | White | Mauve |

| TABLE TOP RISERS | | | | |
|------------------|-------------------------|----------|----------|-------|
| Qty | Description | Discount | Standard | Total |
| | 4' Single Step 12' High | 25.00 | 31.00 | |
| | 6' Single Step 12' High | 35.00 | 44.00 | |
| | 8' Single Step 12' High | 45.00 | 56.00 | |

Charges listed include delivery to your booth and removal at the close of show. If you are looking for furnishings that are not listed please contact Goben CS for request. All ordered furnishings and accessories are rentals, not sales as they must be returned at the end of show.

**THIS FORM MUST BE ACCOMPANIED BY:
 CREDIT CARD BILLING CARD AUTHORIZATION or the
 THIRD PARTY CREDIT CARD BILLING FORM. ORDERS
 WITHOUT PAYMENT CANNOT BE PROCESSED.**

| TABLES | | | | |
|---|---|----------|----------|-------|
| 24" Draped Table | | | | |
| w/white plastic top and draped on 3 sides | | | | |
| Qty | Description | Discount | Standard | Total |
| | 4' long 30" high | 80.00 | 100.00 | |
| | 4' long 42" high | 95.00 | 119.00 | |
| | 6' long 30" high | 95.00 | 119.00 | |
| | 6' long 42" high | 110.00 | 137.00 | |
| | 8' long 30" high | 110.00 | 137.00 | |
| | 8' long 42" high | 125.00 | 156.00 | |
| | To have the 4 th side draped | 27.00 | 34.00 | |

When ordering, please select a color below

| | | | | |
|-------|------|----------|-------|-------|
| Black | Blue | Burgundy | Gold | Peach |
| Gray | Red | Teal | White | Mauve |

| 24" Undraped Table | | | | |
|---------------------|------------------|----------|----------|-------|
| w/white plastic top | | | | |
| Qty | Description | Discount | Standard | Total |
| | 4' long 30" high | 45.00 | 56.00 | |
| | 4' long 42" high | 60.00 | 75.00 | |
| | 6' long 30" high | 60.00 | 75.00 | |
| | 6' long 42" high | 75.00 | 94.00 | |
| | 8' long 30" high | 75.00 | 94.00 | |
| | 8' long 42" high | 90.00 | 113.00 | |

| ROUND COCKTAIL TABLES | | | | |
|---|-----------------------|----------|----------|-------|
| (Tables are laminated and do not come with a table skirt. Spandex coverings are available at an additional charge in the special booth drape) | | | | |
| Qty | Description | Discount | Standard | Total |
| | 24" Diameter 30" High | 65.00 | 81.00 | |
| | 24" Diameter 42" High | 70.00 | 87.00 | |
| | 30" Diameter 30" High | 80.00 | 100.00 | |
| | 30" Diameter 42" High | 85.00 | 106.00 | |
| | 36" Diameter 30" High | 95.00 | 119.00 | |
| | 36" Diameter 42" High | 100.00 | 125.00 | |

| CUSTOM BAR STOOLS & COCKTAIL TABLE | | | | |
|------------------------------------|-------------------------------|----------|----------|-------|
| Black or White (mix & match) | | | | |
| Qty | Description | Discount | Standard | Total |
| | Bar stool (adjustable height) | \$145.00 | \$181.00 | |
| | Cocktail table | \$155.00 | \$193.00 | |

- Sofas are available upon request.
- Martini Bar available upon request.

| | |
|-----------------------|--|
| Furnishings Subtotal: | |
| Sales Tax: 7% | |
| Furnishings Total: | |



1600 33rd Street, Unit 102
Orlando, Florida 32839
T. 407.872.2223 F. 407.872.8644
Email: orders@gobencs.com

credenza/computer

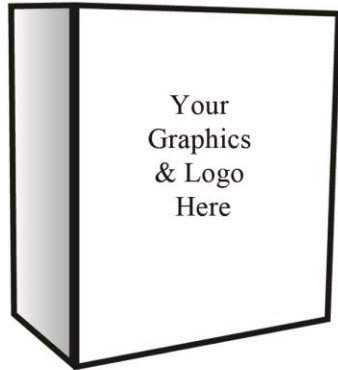

Your
Graphics
& Logo
Here

Credenza - Option 1A (1 Meter)
Option 1B (2 Meter)

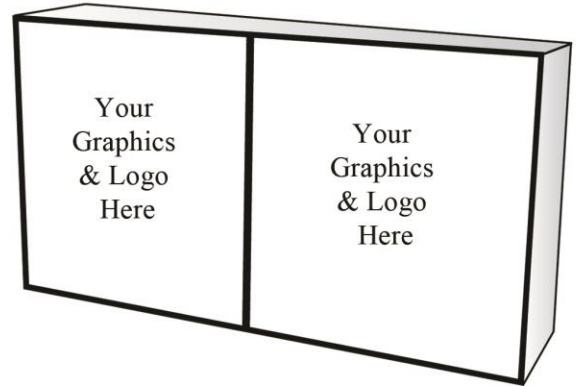

Your
Graphics
& Logo
Here

Your
Graphics
& Logo
Here

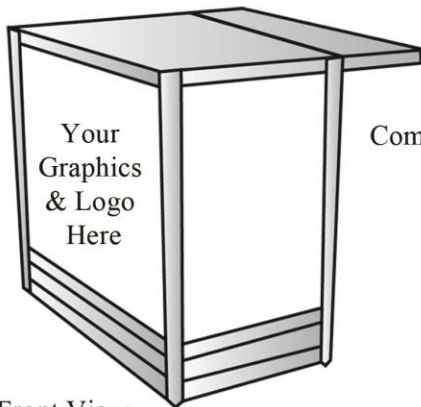

Your
Graphics
& Logo
Here

Computer Kiosk - Option 2

Front View

Internet Café - Option 3A (Single sided)
Option 3B (Double sided)

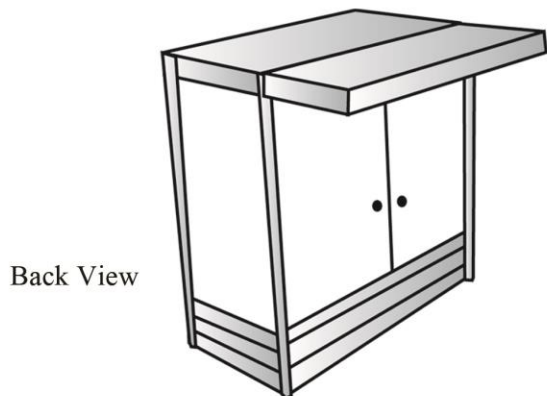
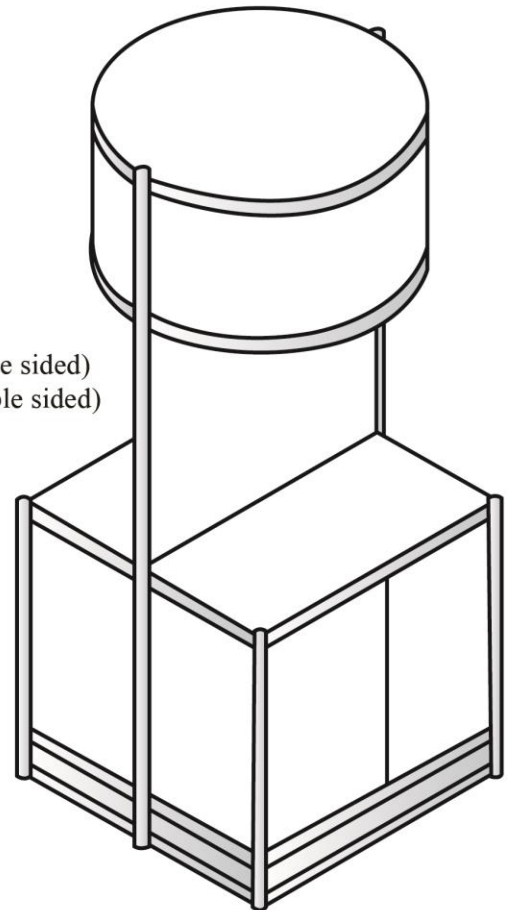

Back View



1600 33rd Street, Unit 102
Orlando, Florida 32839
T. 407.872.2223 F.
407.872.8644
Email: orders@gobencs.com

custom rental units

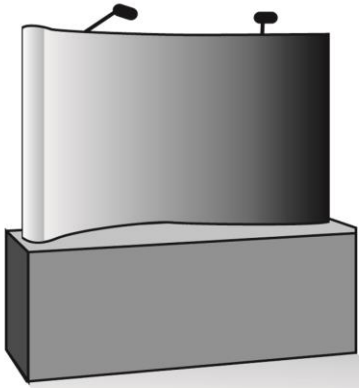
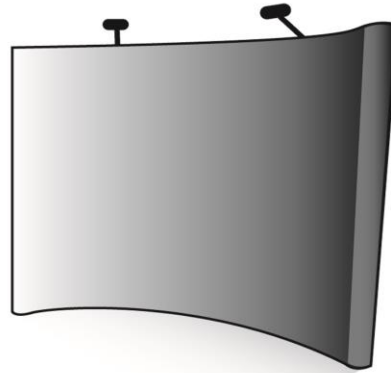

Table Top Display - Option 4



8' Popup Display - Option 5

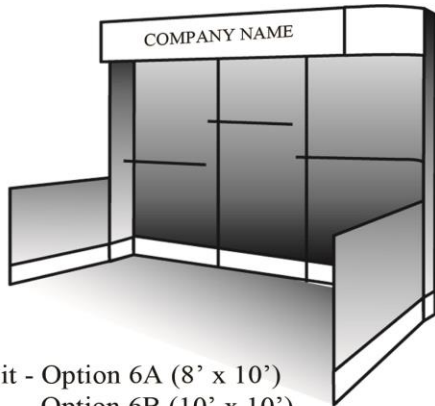

Exhibit - Option 6A (8' x 10')
Option 6B (10' x 10')

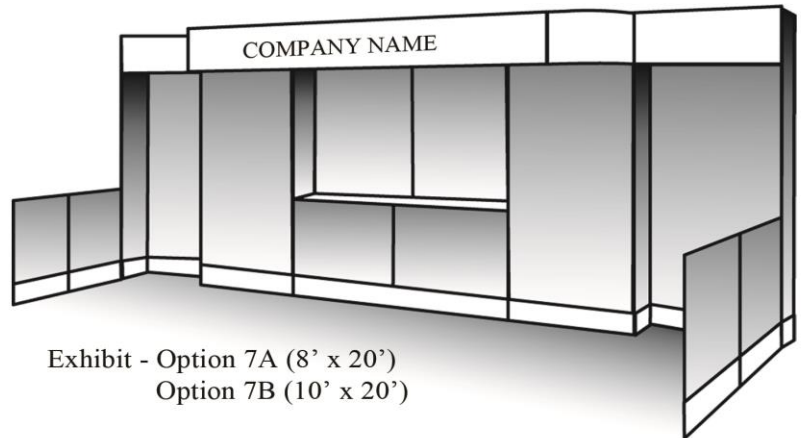
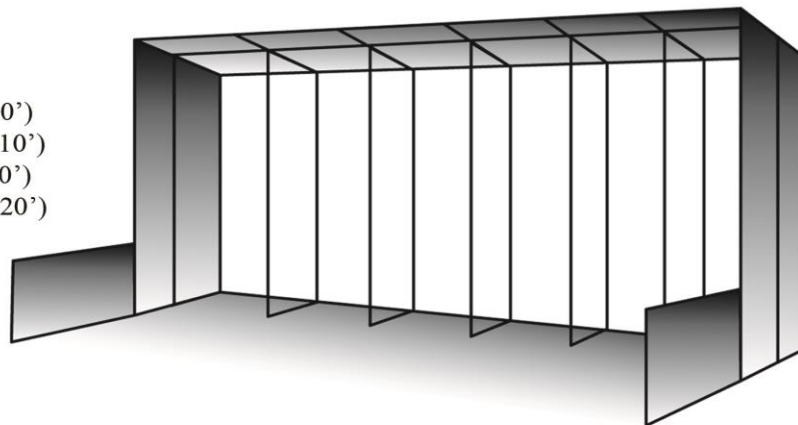

Exhibit - Option 7A (8' x 20')
Option 7B (10' x 20')

Exhibit - Option 8A (8' x 10')
Option 8B (10' x 10')
Option 8C (8' x 20')
Option 8D (10' x 20')





1600 33rd Street, Unit 102
Orlando, Florida 32839
T. 407.872.2223 F. 407.872.8644
Email: orders@gobencs.com

rental unit order

| | |
|---------------------|--|
| Exhibiting Company: | |
| Booth: | |

| Credenza & Computer kiosk's (white panels) | | | | |
|--|--------|--------------|----------|-------|
| Qty | Option | Discount | Standard | Total |
| | 1A | \$298 | \$372 | |
| | 1B | \$398 | \$497 | |
| | 2 | \$385 | \$481 | |
| | 3A | \$650 | \$810 | |
| | 3B | \$975 | \$1200 | |

| Additional options available | | | | |
|------------------------------|-----------------------|-----------------|----------|-------|
| Qty | Option | Discount | Standard | Total |
| | Colored panels | \$110.00 | \$137.00 | |
| | Black | | | |
| | Gray | | | |
| | Blue | | | |
| | Lockable Doors | \$25.00 | \$31.00 | |
| | Company Logo/Graphics | Call | | |

| Table Top & Pop Up | | | | |
|--------------------|--------|--------------|----------|-------|
| Qty | Option | Discount | Standard | Total |
| | 4 | \$260 | \$325 | |
| | 5 | \$560 | \$700 | |
| | Black | | | |
| | Blue | | | |

| Step 1 - Custom Rental Exhibit (6 & 7) | | | | |
|--|--------|---------------|----------|-------|
| Qty | Option | Discount | Standard | Total |
| | 6A | \$1600 | \$2000 | |
| | 6B | \$1600 | \$2000 | |
| | 7A | \$3500 | \$4370 | |
| | 7B | \$3500 | \$4370 | |

| Choose your sintra panel colors | |
|---------------------------------|-------|
| | White |
| | Black |

| Step 1 - Custom Rental Exhibit (8) | | | | |
|------------------------------------|--------|---------------|----------|-------|
| Qty | Option | Discount | Standard | Total |
| | 8A | \$2000 | \$2500 | |
| | 8B | \$2000 | \$2500 | |
| | 8C | \$3850 | \$4800 | |
| | 8D | \$3850 | \$4800 | |

| Choose your Plexi Glass colors | |
|--------------------------------|--------------------|
| | White |
| | Blue |
| | Blue & White (mix) |

Bring your exhibit to life with our eye catching color panels. Choose from our standard colors & Materials or you may also order designer panels - colors are available upon request.

All orders and accessories are rentals, not considered sales as they must be returned at the end of show.



**THIS FORM MUST BE ACCOMPANIED BY:
CREDIT CARD BILLING CARD AUTHORIZATION or the
THIRD PARTY CREDIT CARD BILLING FORM. ORDERS
WITHOUT PAYMENT CANNOT BE PROCESSED.**

| Step 2 - Choose your Carpet Color | | | |
|-----------------------------------|-------|--|--------------|
| | Black | | Burgundy |
| | Gray | | Teal |
| | Blue | | Hunter Green |
| | Red | | |

| Step 3 - Clearly Indicate your Header Copy | | | |
|--|--|--|--|
| | | | |

| Step 4 - Choose your Letter Coloring | | | |
|--------------------------------------|-------|--|--------------|
| | Black | | Burgundy |
| | Gray | | Teal |
| | Blue | | Hunter Green |
| | Red | | Yellow |

If color selection is not indicated the color will be Black.

| Step 5 - Choose your Accessories | | | | |
|----------------------------------|-----------------------|----------------|----------|-------|
| Qty | Option | Discount | Standard | Total |
| | Double sided Velcro | call | call | |
| | Clip on Spotlights | \$35.00 | \$44.00 | |
| | Ground spot lights | \$35.00 | \$44.00 | |
| | Power Strip | \$15.00 | \$19.00 | |
| | Extension Cord | \$15.00 | \$19.00 | |
| | Additional Flat Shelf | \$30.00 | \$38.00 | |
| | Literature rack | \$70.00 | \$88.00 | |

| Special Artwork or logos will be quoted upon request. Please email samples with this order and comments below | |
|--|--|
| | |

Custom Rental Unit (6 & 7) price Includes:
Delivery, set up and removal at the close of show.
Lights, Company header in block lettering and carpet .
Custom Rental Unit (8) includes: The above minus the header.

Remember to order the following items as desired. They are NOT included with the units. Graphics, logos, Furniture, Electrical, Floral & cleaning service.

All packages can be customized or modified, depending on your specific requirements.

| | |
|---------------------|--|
| Exhibit Rental Unit | |
| Accessories | |
| Sales Tax: 7% | |
| Total: | |



1600 33rd Street, Unit 102
Orlando, Florida 32839
T. 407.872.2223 F. 407.872.8644
Email: orders@gobencs.com

carpet & padding

| | |
|---------------------|--|
| Exhibiting Company: | |
| Booth: | |

IN- LINE BOOTH CARPET

| Check One | Size | Discount | Standard | Total |
|-----------|-----------|----------|----------|-------|
| | 08' x 10' | \$135.00 | \$168.00 | |
| | 10' x 10' | \$135.00 | \$168.00 | |
| | 10' x 20' | \$270.00 | \$336.00 | |
| | 10' x 30' | \$405.00 | \$504.00 | |

| |
|-------|
| Black |
| Gray |
| Blue |
| Red |

| |
|--------------|
| Burgundy |
| Teal |
| Hunter Green |
| |

Booth carpet includes tape on the front, towards the aisle.

CARPET PADDING & VISQUEEN

| Padding | Booth Size | | Discount | | Standard | |
|----------|------------|-------|----------|---|----------|--------------|
| ½" Thick | X | Ft. = | Sq ft. | X | \$0.80 | Or \$1.00 \$ |
| 1" Thick | X | Ft. = | Sq ft. | X | \$1.60 | Or \$2.00 \$ |

| Visqueen | Booth Size | | Discount | | Standard | |
|----------|------------|-------|----------|---|----------|--------------|
| | X | Ft. = | Sq ft. | X | \$0.80 | Or \$1.00 \$ |

Rates are calculated at Per Square Foot

CARPET TAPE

| Lineal Ft. | | Rate |
|------------|---|-----------|
| | X | \$1.65 \$ |

Most facilities require taping of the front edge of carpet for safety purposes.

ISLAND BOOTH - SPECIAL CUT CARPET

| Booth Size | | | Discount | | Standard | |
|------------|---|-------|----------|---|----------|--------------|
| | X | Ft. = | Sq ft. | X | \$2.50 | Or \$3.10 \$ |

Rates are calculated at Per Square Foot ~ Minimum of 100 square feet

DELUX CARPET

| Booth Size | | | Discount | | Standard | |
|------------|---|-------|----------|---|----------|--------------|
| | X | Ft. = | Sq ft. | X | \$3.25 | Or \$4.05 \$ |

Rates are calculated at Per Square Foot ~ Minimum of 200 square feet

When ordering please select a color below

| | | |
|-------|----------|------|
| Black | Burgundy | Blue |
| Red | Teal | Gray |

Additional colors available upon request

No Refunds will be issued on Special Cut or Deluxe orders as these items will be cut and or ordered specifically for you.

Listed prices on carpet include delivery, installation and removal. Carpet Ordered in multiples are not guaranteed in a color match. Custom carpet orders after the deadline date are subject to availability.

THIS FORM MUST BE ACCOMPANIED BY:
CREDIT CARD BILLING CARD AUTHORIZATION or the
THIRD PARTY CREDIT CARD BILLING FORM

| | |
|------------------|--|
| Carpet Subtotal: | |
| Sales Tax: 7% | |
| Carpet Total: | |



1600 33rd Street, Unit 102
 Orlando, Florida 32839
 T. 407.872.2223 F. 407.872.8644
 Email: orders@gobencs.com

cleaning services

| | |
|---------------------|--|
| Exhibiting Company: | |
| Booth: | |

Please note vacuuming and emptying booths is not part of your booth space rental. If you require these services they must be ordered.

| EMPTY WASTEBASKET ONLY |
|---|
| Wastebasket will be emptied at the end of the day |

| Booth Size | X | Ft. = | Sq ft. | X | Rate | X # of Days | \$ |
|------------|---|-------|--------|---|--------|-------------|----|
| | X | | | X | \$0.25 | | \$ |

| ONE TIME BOOTH CLEANING |
|--|
| Vacuum & Empty wastebasket prior to show opening |

| Booth Size | X | Ft. = | Sq ft. | X | Rate | \$ |
|------------|---|-------|--------|---|--------|----|
| | X | | | X | \$0.32 | \$ |

| DAILY BOOTH CLEANING |
|--|
| Cleaning done prior to show open and each morning before show starts |

| Booth Size | X | Ft. = | Sq ft. | X | Rate | X # of Days | \$ |
|------------|---|-------|--------|---|--------|-------------|----|
| | X | | | X | \$0.29 | | \$ |

| PORTER SERVICE |
|--|
| Per 10' booth space |
| Price includes emptying wastebasket and policing exhibit area at two hour intervals during show up to a maximum of 8 hours straight time |

| # of 10' sections | X | Rate | X # of Days | \$ |
|-------------------|---|---------|-------------|----|
| | X | \$80.00 | | \$ |

| POPCORN MACHINE |
|--|
| If you plan to bring in a popcorn machine you must notify us in advance and acquire the necessary approval from show management and the venue. You will be charged a daily cleaning fee due to the labor involved to keep the show floor clear of popcorn. |

| # of Popcorn Machines | X | Rate | X # of Days | \$ |
|-----------------------|---|---------------|-------------|----|
| | X | Call for rate | | \$ |

All rental carpets are delivered clean to your booth, however during exhibitor setup should the carpet become soiled, we suggest that you order the basic cleaning services prior to show opening at its current prevailing rate. All rates are based on gross square footage of your booth with a 100 square foot minimum per day. When ordering daily cleaning, you must order for every show day.

THIS FORM MUST BE ACCOMPANIED BY:
 CREDIT CARD BILLING CARD AUTHORIZATION or the
 THIRD PARTY CREDIT CARD BILLING FORM

| | |
|--------------------|--|
| Cleaning Subtotal: | |
| Sales Tax: 7% | |
| Cleaning Total: | |



1600 33rd Street, Unit 102
 Orlando, Florida 32839
 T. 407.872.2223 F. 407.872.8644
 Email: orders@gobencs.com

Sign & Graphics

| | | | |
|--------------------|--|---------|--|
| Exhibiting Company | | Booth # | |
| Contact Email | | Phone # | |

Digital Graphics:

Goben CS has the capabilities to provide you with the finest digital graphic reproduction available.

Capabilities include four-color photo-quality, high-resolution digital printing for banners, signage, exhibit graphics and more.

STANDARD SIZES

| Qty | SIZE | MATERIAL | Thickness | Discount | Standard | Total |
|-----|-----------|------------|-----------|----------|----------|-------|
| | 11" x 17" | Foam Board | 3/16" | \$40.00 | \$50.00 | |
| | 22" x 28" | Foam board | 3/16" | \$64.00 | \$80.00 | |
| | 24" x 36" | Ultramount | 3/16" | \$94.00 | \$117.00 | |
| | 28" x 44" | Ultramount | 3/16" | \$132.00 | \$165.00 | |
| | | Misc Other | | | | |

| Qty | DIRECTIONAL BOARDS (½" Foam board) | Size | Discount | Standard | Total |
|-----|------------------------------------|---------|----------|----------|-------|
| | Single sided | 2' x 5' | \$138.00 | \$172.00 | |
| | Double sided | 2' x 5' | \$243.00 | \$243.00 | |
| | Meter Board - Single sided | 3' x 7' | \$324.00 | \$405.00 | |
| | Meter Board - Double sided | 3' x 7' | \$558.00 | \$697.00 | |
| | Half Moon Feet (Foam board) | | \$30.00 | \$37.00 | |
| | Spider Feet (Metal) | | \$30.00 | \$37.00 | |

| Qty | HANGING BANNERS (With Grommets) | Size | Discount | Standard | Total |
|-----|---|---------|----------|----------|-------|
| | Single sided Economy (one time use) | 4' x 6' | \$216.00 | \$270.00 | |
| | Single Sided – Heavy duty material (Multi Use) | 4' x 6' | \$280.00 | \$350.00 | |
| | Double Sided – Heavy Duty (Multi Use) | 4' x 6' | \$518.00 | \$647.00 | |
| | Single sided Economy (one time use) | 4' x 8' | \$288.00 | \$360.00 | |
| | Single Sided – Heavy duty material for multi use. | 4' x 8' | \$374.00 | \$467.00 | |
| | Double Sided – Heavy Duty (Multi Use) | 4' x 8' | \$691.00 | \$863.00 | |

GRAPHIC FILE COMPATABILITY INFO (To be emailed)

- CMYK JPEGs - 150ppi at full size (300ppi scaled to 50% for example)
- Print ready PDF (PDF/X-1a:2001) or (High Quality Print) setting. Any bitmap images down sampled 150ppi at full size.
- Adobe Illustrator, Photoshop or InDesign up to CS5. All bitmap links, 150ppi at full size.

We can also accept some of the more common graphic format files such as .tif, jpg, .pcx, gif, etc. However, these files are bitmap images that are resolution-reliant. A low resolution doc may be fine for a web page or business card, when it is enlarged for a big sign or banner, the image suffers in that it becomes blurry or pixilated with "stair stepped" edges. When sending bitmap files for large graphics the higher the resolution the better.

If in doubt, or have any questions, please contact us at info@gobencs.com

















THIS FORM MUST BE ACCOMPANIED BY:
 CREDIT CARD BILLING CARD AUTHORIZATION or the
 THIRD PARTY CREDIT CARD BILLING FORM. ORDERS
 WITHOUT PAYMENT CANNOT BE PROCESSED.

| | |
|-----------------------|--|
| Furnishings Subtotal: | |
| Sales Tax: 7% | |
| Furnishings Total: | |



1600 33rd Street, Unit 102
 Orlando, Florida 32839
 T. 407.872.2223 F. 407.872.8644
 Email: orders@gobencs.com

floral & foliage

| | A | B | C | D |
|---|---|---|--|---|
| Option 1 |  |  |  |  |
| | Boston Fern | Pothos | Ivy | Orchid |
| Option 2 Flowering |  |  |  |  |
| | Kalanchoes | Blooming mum | Azalea | Bromeliad |
| Option 3 2' |  |  |  |  |
| | Ficus Bush | Arboricola | Spathiphyllum | Croton |
| Option 4 3' - 4' 5' |  |  |  |  |
| | Ficus Standard | Cat Palm | Bird of Paradise | Marginata |
| Option 5 6' 7' & taller Special order |  |  |  |  |
| | Palm | Majesty Palm | Adonidia Double | Ficus Standard |



1600 33rd Street, Unit 102
 Orlando, Florida 32839
 T. 407.872.2223 F. 407.872.8644
 Email: orders@gobencs.com



| | |
|---------------------------------|--|
| Exhibiting Company Name: | |
| Booth# | |

| |
|---|
| DISCOUNT DEADLINE July 21, 2017 |
| Specialty Orders must be received by July 28, 2017 |

Order Details

Goben CS reserves the right to make substitutions if a particular item is not available at the time of show. Goben CS will select at no risk.
 All flowering plants are based upon availability.
 If you are looking for arrangements that are not listed, please give Goben Convention Services a call for pricing and availability.

FLORAL – FOILAGE – LIVE PLANTS

| Option 1 | | | | |
|----------|-----------|----------------|----------|-------|
| Qty | Option | Discount | Standard | Total |
| | A (small) | \$45.00 | \$56.00 | |
| | A (large) | \$79.00 | \$98.75 | |
| | B | \$40.00 | \$50.00 | |
| | C | \$40.00 | \$50.00 | |
| | D | \$50.00 | \$62.00 | |

| Option 5 | | | | | |
|----------|---------|------|-----------------|----------|-------|
| Qty | Option | Size | Discount | Standard | Total |
| | A | 6' | \$135.00 | \$169.00 | |
| | B | 6' | \$135.00 | \$169.00 | |
| | C | 6' | \$135.00 | \$169.00 | |
| | D | 6' | \$135.00 | \$169.00 | |
| | A,B,C,D | 7' | | (Call) | |

| Option 2 (Seasonal) | | | | |
|---------------------|--------|----------------|----------|-------|
| Qty | Option | Discount | Standard | Total |
| | A | \$40.00 | \$50.00 | |
| | B | \$40.00 | \$50.00 | |
| | C | \$40.00 | \$50.00 | |
| | D | \$45.00 | \$56.00 | |

| Floral Arrangements | | | | |
|---------------------|--------------------------|-----------------|----------|-------|
| Qty | Description | Discount | Standard | Total |
| | 12" Arrangement | \$93.00 | \$116.00 | |
| | 24" Arrangement | \$116.00 | \$145.00 | |
| | 12" Tropical Arrangement | \$132.00 | \$165.00 | |
| | 24" Tropical Arrangement | \$171.00 | \$213.00 | |
| | Custom Arrangement | | (call) | |

| Option 3 | | | | | |
|----------|--------|------|----------------|----------|-------|
| Qty | Option | Size | Discount | Standard | Total |
| | A | 2' | \$47.00 | \$59.00 | |
| | B | 2' | \$47.00 | \$59.00 | |
| | C | 2" | \$47.00 | \$59.00 | |
| | D | 2' | \$47.00 | \$59.00 | |

| Color Preference (if available) | |
|---------------------------------|--|
| | |

| Option 4 | | | | | |
|----------|--------|---------|----------------|----------|-------|
| Qty | Option | Size | Discount | Standard | Total |
| | A | 3' - 4' | \$63.00 | \$79.00 | |
| | B | 3' - 4' | \$63.00 | \$79.00 | |
| | C | 3' - 4' | \$63.00 | \$79.00 | |
| | D | 3' - 4' | \$63.00 | \$79.00 | |
| | A | 5' | \$79.00 | \$99.00 | |
| | B | 5' | \$79.00 | \$99.00 | |
| | C | 5' | \$79.00 | \$99.00 | |
| | D | 5' | \$79.00 | \$99.00 | |

| SILK ARRANGEMENTS | | | | |
|-------------------|--------------------|-----------------|----------|-------|
| Qty | Option | Discount | Standard | Total |
| | Ivy | \$25.00 | \$32.00 | |
| | Floral Arrangement | \$65.00 | \$82.00 | |
| | 4' Green Plant | \$48.00 | \$60.00 | |
| | 6' Green Plant | \$74.00 | \$93.00 | |
| | 9' Green Plant | \$135.00 | \$169.00 | |

Charges listed include delivery to your booth and removal at the close of show.
 No credit or refunds will be issued on floral orders cancelled within 5 days of delivery.
 All ordered are rentals, not considered sales as they must be returned at the end of show.
 Note: Damaged or stolen plants are Exhibitors Responsibility, to be paid for at retail value.

**THIS FORM MUST BE ACCOMPANIED BY: CREDIT CARD BILLING CARD AUTHORIZATION OR THIRD PARTY CREDIT CARD BILLING FORM.
 ORDERS WITHOUT PAYMENT CANNOT BE PROCESSED**

| | |
|-----------------|--|
| Services | |
| Subtotal: | |
| Sales Tax: | |
| 7% | |
| Services Total: | |



1600 33rd Street, Unit 102
 Orlando, Florida 32839
 T. 407.872.2223 F. 407.872.8644
 Email: orders@gobencs.com

audio visual

| | |
|---------------------------------|--|
| Exhibiting Company Name: | |
| Booth# | |

**Please note pricing is charged on a daily rate, however max charge will be 3 days
 A wide range of items are available. If they are not listed below please call for pricing and availability.**

| Monitors (Flat screen) | | | | | |
|-------------------------------|------------------|-----------|-----------------|----------|-------|
| Qty | Description Size | # of Days | Daily Rates | | Total |
| | | | Discount | Standard | |
| | 19" LED | | \$70.00 | \$87.50 | |
| | 23" LED | | \$125.00 | \$156.00 | |
| | 32" LED | | \$250.00 | \$312.00 | |
| | 42" LED | | \$300.00 | \$375.00 | |
| | 46" LED | | \$350.00 | \$438.00 | |
| | 50" LED | | \$400.00 | \$500.00 | |
| | 55" LED | | \$450.00 | \$562.00 | |
| | 60" LED | | \$550.00 | \$687.00 | |

| Monitor Stands (required for 32" Monitors and up) | | | | | |
|--|-------------|-----------|----------------|----------|-------|
| Qty | Description | # of Days | Daily Rates | | Total |
| | | | Discount | Standard | |
| | Table Stand | | \$25.00 | \$31.25 | |
| | Wall Mount | | \$25.00 | \$31.25 | |
| | Floor Stand | | \$75.00 | \$94.00 | |

| Computers | | | | | |
|------------------|------------------|-----------|-----------------|----------|---------|
| Qty | Description | # of Days | Daily Rates | | Total |
| | | | Discount | Standard | |
| | Laptop Computer | | \$125.00 | \$156.00 | |
| | iMac 27" Core i7 | | \$350.00 | \$437.00 | |
| | Software Licence | | 30.00 | - | \$30.00 |

| Office Equipments | | | | | |
|--------------------------|-------------------------|-----------|-----------------|----------|-------|
| Qty | Description | # of Days | Daily Rates | | Total |
| | | | Discount | Standard | |
| | Wireless Keyboard/mouse | | \$25.00 | \$32.00 | |
| | Fax Machine | | \$75.00 | \$94.00 | |
| | HP Laser Printer | | \$125.00 | \$156.00 | |
| | Table Top Copier | | \$125.00 | \$156.00 | |

| Projection Equipment (LCD Projectors) | | | | | |
|--|--------------------------|-----------|-----------------|----------|-------|
| Qty | Description | # of Days | Daily Rates | | Total |
| | | | Discount | Standard | |
| | Sanyo (3000 lumen) | | \$300.00 | \$375.00 | |
| | Sanyo (5000 lumen) | | \$600.00 | \$750.00 | |
| | Single mount flyware | | \$30.00 | \$37.00 | |
| | Lenses available | | Call | | |
| | 6' Tripod Screen | | \$35.00 | \$44.00 | |
| | 8' Tripod Screen | | \$40.00 | \$50.00 | |
| | 10' Cradle Screen | | \$75.00 | \$94.00 | |
| | 6' x 8' Fast Fold Screen | | | | |
| | Front | | \$75.00 | \$94.00 | |
| | Rear | | \$85.00 | \$107.00 | |
| | Trim | | \$85.00 | \$106.00 | |

| Video Players | | | | | |
|----------------------|----------------------|-----------|-----------------|----------|-------|
| Qty | Description | # of Days | Daily Rates | | Total |
| | | | Discount | Standard | |
| | DVD Player | | \$40.00 | \$50.00 | |
| | DVD Blue Ray | | \$80.00 | \$100.00 | |
| | DVD Multi Zone | | \$125.00 | \$157.00 | |
| | Pro DVD Player | | \$125.00 | \$157.00 | |
| | DVD Blu Ray Recorder | | \$200.00 | \$250.00 | |

| iPad Kiosk (for iPad 2 & 3) Locks iPad securely | | | | | |
|--|-------------|-----------|-----------------|----------|-------|
| Qty | Description | # of Days | Daily Rates | | Total |
| | | | Discount | Standard | |
| | iPad Kiosk | | \$120.00 | \$150.00 | |

**Exhibitors are required to provide the necessary cables to hook up devices to TV/Monitors.
 If you request Gobencs to provide the necessary cables then you must specify the cables required.
 Standard cables are available for rent at a cost of \$10 each
 Specialty cables are also available. Gobencs must be contacted in order to confirm availability.**

Rental Procedures:

All equipment will be delivered, installed and tested.
 A service fee (delivery & pick up) equal to 20% of the equipment subtotal will be charged on all rentals. (minimum \$50)
 Cancellation fees of 25% will apply to orders cancelled within 5 days of delivery.
 All ordered furnishings and accessories are rentals, not considered sales, they must be returned at the end of show.
 Customer is responsible for contacting the electrical contractor for power requirements.

**THIS FORM MUST BE ACCOMPANIED BY:
 CREDIT CARD BILLING CARD AUTHORIZATION or the
 THIRD PARTY CREDIT CARD BILLING FORM. ORDERS
 WITHOUT PAYMENT CANNOT BE PROCESSED.**

| | |
|---|--|
| Equipment Total | |
| Sales Tax 7% (Equipment rental only) | |
| Service fee 20% (Equipment total only) | |
| Total | |



1600 33rd Street, Unit 102
Orlando, Florida 32839
T. 407.872.2223 F. 407.872.8644
Email: orders@gobencs.com

labor & forklift

| | |
|---------------------|--|
| Exhibiting Company: | |
| Booth: | |

LABOR RATES & DETAILS

| LABOR RATES | |
|----------------------|-------------------------|
| Straight Time | \$69.00 p/p/p/h |
| Overtime | \$90.00 p/p/p/h |
| Double-Time | \$138.00 p/p/p/h |

The current listed hourly rates are listed at a per person, per hour as indicated by p/p/p/h. Work will be done on a straight time basis if possible. However, overtime charges will be involved on all show floor orders.

OVERTIME HOURS

Overtime hours are before 8:00am or after 4:30pm Monday – Friday and all day Saturday. Overtime hours are also applied to labor services ordered on show-site regardless of the time.

DOUBLE-TIME HOURS

Double-time hours are Monday- Saturday 12:00 midnight - 6:00am and all day Sunday and Holidays.

NON-USE OF ORDERED LABOR SERVICES

If an exhibitor fails to pick up labor time as ordered, a 1 (one) hour per worker no show charge will be applied to the clients invoice.

LABOR PLAN A Supervision by Goben Convention Services

Exhibits will be setup prior to exhibitor's arrival under the direction of Goben Convention Services Personnel.

The supervision charge for this service is 30% of the total labor bill, with a minimum charge of \$40.00.

LABOR PLAN B Supervision by Exhibiting Personnel

Supervisor must check in a Service Desk to pick up laborers.

Upon completion of work, supervisor must return to the service desk to release laborers.

Start time only guaranteed where labor is requested at the start of the working day, unless the official setup time is later in the day.

Workers are assigned orders and completion time of their assignments is uncertain. Therefore starting time cannot be guaranteed although every effort will be made to provide labor at requested times

Selection of Labor Plan:
(Select One)

| | |
|--------------------------|---------------------|
| <input type="checkbox"/> | Labor Plan A |
| <input type="checkbox"/> | Labor Plan B |

Upon selection, fill out the details of your labor plan below

| | Date | Time | # of Laborers | Hours per Laborer | Hourly Rate | Total Cost |
|--------------------|------|------|---------------|-------------------|-------------|------------|
| Install | | | | | | |
| Dismantle | | | | | | |
| Supervision | | | | | | |
| Total | | | | | | |

FORKLIFT ORDER – 5000lbs

| FORKLIFT LABOR RATES | |
|----------------------|--------------------------|
| Straight Time | \$188.00 per hour |
| Overtime | \$235.00 per hour |
| Double-Time | \$376.00 per hour |

A forklift operator and crew will be assigned at the following rates per hour. If additional personnel are required to assist, you will be billed at the hourly labor rates. Forklift crews do not need to be ordered if this is part of the material handling process. Orders received after the discount date will incur a 20% surcharge. Order received on-site will incur a 30% surcharge.

| | Date | Time | Additional Laborers | Hours Per Laborer | Hourly Rate | Total Cost |
|------------------|------|------|---------------------|-------------------|-------------|------------|
| Install | | | | | | |
| Dismantle | | | | | | |

THIS FORM MUST BE ACCOMPANIED BY:
CREDIT CARD BILLING CARD AUTHORIZATION or the
THIRD PARTY CREDIT CARD BILLING FORM. ORDERS
WITHOUT PAYMENT CANNOT BE PROCESSED.

| | |
|--------------------|--|
| Services Subtotal: | |
| Services Total: | |



1600 33rd Street, Unit 102
Orlando, Florida 32839
T. 407.872.2223 F. 407.872.8644
Email: orders@gobencs.com

material handling information

EXCLUSIVE Material Handling Contractor

Goben Convention Services are under contract with AM Nuclear Society. We will handle ALL freight/exhibit material in and out of the ballroom. For your convenience labels are provided in this exhibitor manual. You must return in advance of the show the Method of payment form, along with the completed Material handling service & rates form.

Advance Freight Shipments (Ship as early as possible)

You get 30 days storage included with Material Handling fees!
Warehouse receiving hours are 8:30am – 4:00 pm, Monday – Friday. Shipments can begin arriving July 7th and should arrive no later than Fri, Aug 4th. Shipments that arrive at the advance warehouse after Fri, July 28th will be charged a late fee of 25% of the material handling fee. Please ship to the advance warehouse and you will only be charged one-time. It is much less expensive to ship to the advance warehouse and be charged a one-time material handling fee than to send to the hotel and be charged twice for the same service.

Direct to Show Site Shipments

Do not ship freight to the show-site prior to the move in day!
Freight shipped to the venue before the move in day will either be **REFUSED** or you will be charged a handling & storage fees from the hotel. The freight will then be turned over to Goben CS for delivery to the exhibit hall and you will **ALSO** be charged material handling fees, **even if you are a guest of the hotel.**
Please note: Mislabeled packages have the potential of being refused at show site. Please remember to include AM Nuclear Society c/o Goben CS on all packages AND remove all old labels from packaging.

Overtime +25% (inbound and/or outbound)

A overtime surcharge, per cwt, for each occurrence will apply if:
-Shipments are received on overtime (Monday-Friday, before 8:00am and after 4:30pm and **ALL DAY Saturday, Sunday and Holidays**).
-A surcharge applies if your shipment is moved to or out of show site on overtime due to scheduling beyond Goben CS control.
-A surcharge will apply if your advanced shipment is received at the warehouse on straight-time, but had to be delivered to show site on overtime due to a scheduling beyond the control of Goben CS.

Special Handling +30% (inbound and/or outbound)

A special handling surcharge, per cwt, for each occurrence will apply if:
-Uncrated shipments that must be taken off pallets and hand carried in loose will be charged an additional 30%.
-Van Lines, loose, uncrated or improperly packaged materials, or those delivered by a carrier not providing supporting paperwork will be charged an additional 30%.
- Items that are too large to fit through ballroom doors and must be uncrated in hallway or loading dock
- Goben CS will not be held responsible for the dimensions of the hotel dock doors, freight elevator or the ballroom doors.

UPS, Fed Ex, DHL etc Shipments

Shipments delivered via small package carriers require additional time & Labor to unload, sort & deliver, therefore a special handling fee of 25% will be added to the material handling rate.
The above freight carriers DO NOT provide bills of lading to note any damage or piece count. Therefore, Goben CS will NOT be responsible and will not accept any claims for any reason involving carriers that do not use bills of lading.

Outbound Instructions at close of show

It is the exhibitor's responsibility to arrange outbound shipments with their designated carrier (If other than UPS Freight). Schedule your carrier to pick up your freight, directly from the exhibit hall, no later than the reroute time. (Reroute time is 12:01 Wed, Aug 9th)

*If an exhibitor is shipping out via UPS or Fed Ex and they fail to pick up or the facility does not allow us to turn the items over for their daily pick up, then your items will be taken back to Goben's warehouse to ship out if room allows on our truck. Fees will be apply and will be added to the final invoice. (Also applies to common carriers)

At the close of the show, each exhibitor must fill out a **Bill of Lading and hand in to the on-site service desk**. Outbound shipping forms will be available at the service desk. Should the exhibitor fail to provide outbound shipping paperwork and it is not turned into the service desk, a labor charge will be added to the exhibitor's final invoice.

Any shipment left in a booth for which no disposition is provided, or if requested carrier fails to pick up or refuses to take shipment, Goben Convention Services reserves the right to re-route shipment using UPS Freight or return material to our warehouse at the exhibitor's expense. For more information, please see the Move Out information sheet enclosed in this manual.

Material Handling - Does NOT Include

- Labor and/or equipment for uncrating, un-skidding, assembling, dismantling, re-crating and re-skidding. These services may be ordered by filling out the labor forms included in this manual.
- Scheduling any carrier for pick up or delivery of your materials, if other than the official show carrier (UPS Freight).
- As an exhibitor it is your responsibility for providing your carrier with the proper delivery and pick up information.

Material Handling - DOES Include

- Receiving and unloading your shipment at our warehouse (30 days free storage prior to show date).
- Reloading on the Goben Convention Services trailer.
- Delivery of shipment to the exhibit hall
- Placement of shipment in your booth space
- Removal of empty containers
- Return of empty containers at close of show (All containers must be empty when stored, Goben Convention Services assumes no liability for material or equipment left inside a container marked as empty).
- Removal of all packed and labeled materials from the exhibit booth.
- Reloading on to an outbound carrier for return shipment (based on shipping information provided on your show Bill of Lading).

Charges for the above services will be based on the inbound weight only (each shipment is evaluated separately), whether the above services are used completely or in part. Refer to the material handling services and rates for detailed pricing information.

Weight taken from inbound bill of lading is rounded up to the next hundred pounds. Goben Convention Services will assign a weight to shipments arriving without a bill of lading of certified weight tickets. Shipments received without weight tickets will be charged an additional 30%.

Research + 30%

If exhibitor name, show name etc is not visible on the shipping label, a research rate will apply in addition to your material handling rate.



1600 33rd Street, Unit 102
Orlando, Florida 32839
T. 407.872.2223 F. 407.872.8644
Email: orders@gobencs.com

material handling information (con't)

Money Saving Tips

Consolidate shipments when total weight is less than 200lbs.
3 Separate Shipments 1 Consolidated Shipment
65lbs charged @ 200lbs \$148.00 3 pieces (1 shipment)
89lbs charged @ 200lbs \$148.00 196lbs @ 200lbs = \$148.00
42lbs charged @ 200lbs \$148.00 **Total Savings: \$296.00**
Total 196lbs Total cost \$444.00

Additional charges may be applicable to the CWT rates

Recommended Inbound & Outbound Freight Carrier

UPS Freight is the preferred show carrier. If you use UPS Freight you do not need to worry about scheduling freight carriers, waiting charges or forced freight shipments.



CONVENIENT 24 HOUR TRACKING

800.988.9889
www.UPSfreight.com
UPS FORM LOCATED AT THE BACK OF THIS MANUAL
MENTION SHOW NAME FOR DISCOUNTED SHOW RATES

Misc Material Handling Information

-Goben Convention Services will not be responsible for piece count or condition of shipments that are delivered without supporting bill of lading or delivery slip.
- Remember that all shipments must be PREPAID, DO NOT SHIP "COLLECT". All shipments sent "COLLECT" WILL BE REFUSED.
You may confirm receipt of your shipment by calling Gobencs 407.872.2223
-Exhibitors can hand carry their own materials into the exhibit hall, provided they use their personal vehicle and company employees to do so. Freight being delivered to the loading dock in vehicle other than personal must be unloaded and delivered by Gobencs Convention Services.
Due to insurance purposes.....No material handling equipment such as dollies or pallet jacks shall be used by anyone other than Gobencs CS.
-If you have brought in your own materials in and wish to have Gobencs CS store your empty containers, there will be a charge of \$20.00 per item or \$0.20c per lb whichever is greater.
-Shrink wrap and banding will incur a one ½ hour labor charge.

Empty Container Storage

Storage of empty containers is included with your material handling service. Empty containers must be labeled with an "empty" sticker. Before the show opens, all trash will be removed from the aisles, Gobencs CS is NOT responsible for containers nor packaging materials that are not properly labeled with "empty" stickers. Stickers are available at the service desk.
If you do not use Gobencs CS material handling service but would like your empty containers stored during the show, there is a fee of \$25.00 per piece for storage.

Return to Gobencs Convention Services Warehouse

If you wish to have your freight returned to Gobencs Convention Services Warehouse, prior arrangements must be made with our office staff. Please note that Gobencs Convention Services warehouse address may NOT be the same as the advanced shipping address.

Short Term / Long Term Storage Options

Storage facilities are available for short and long term, please call for a quote if there is interest for this service.

Insurance

It is understood that Gobencs Convention Services is not an insurer that insurance, if any, should be obtained by the exhibitor. Exhibitors are recommended to carry All-Risk Insurance covering your materials against damage, loss and all other hazards from the time of shipping to returning from show. This can usually be done by adding "riders" to existing policies.

Limitation of Liability & Responsibility

Gobencs Convention Services shall not be responsible for damage to uncrated materials; materials improperly packed or concealed damage.

Gobencs Convention Services shall not be responsible for loss, theft or disappearance of exhibitor's materials after same has been delivered to exhibitor's booth.

Gobencs Convention Services shall not be responsible for loss, theft or disappearance of materials before they are picked up from exhibitor's booth for reloading after the show. Bills Of Lading covering outgoing shipment, which are furnished by Gobencs Convention Services to exhibitors will be checked at time of actual pick up from the booth and corrections are made where discrepancies occur.

Gobencs Convention Services shall not be responsible for loss, damage or delay due to fire, Acts of God, strikes, lockouts or work stoppages made where discrepancies occur.

Gobencs Convention Services Liability shall be limited to the physical loss of or damage to specific article which is lost or damaged, and in any event Gobencs Convention Services maximum liability shall be limited to \$0.30 per pound per article with a maximum liability of \$50.00 per item, or \$1,000.00 per shipment, whichever is less.

Claims for loss or damage must be submitted to Gobencs Convention Services prior to the close of show. No suit or action shall be brought against Gobencs Convention Services more than one year after the accrual of the cause of action.

The consignment or delivery of a shipment to Gobencs Convention Services by an exhibitor, or by any shipper to or on behalf of the exhibitor, shall be construed as an acceptance by such exhibitor (and/or other shipper) of the terms and conditions set forth.

Empty container labels will be available at the Gobencs Convention Services Desk. Affixing the labels is the sole responsibility of the exhibitor or his/her representative. All previous labels should be removed or obliterated. Gobencs Convention Services assumes no responsibility for:

- Error to above procedures
- Removal of Containers with old empty labels and without Gobencs Convention Services Labels.
- Improper Information on Empty Labels
- Materials stored in container with empty labels.



1600 33rd Street, Unit 102
Orlando, Florida 32839
T. 407.872.2223 F. 407.872.8644
Email: orders@gobencs.com

material handling service & rates

| | |
|---------------------|--|
| Exhibiting Company: | |
| Booth: | |

| |
|---|
| ADVANCE WAREHOUSE ADDRESS |
| DNL Logistics c/o UPS Freight 14476 Duval Place, West, #501 Jacksonville, FL 32218 (last warehouse on right) |
| Must be received by Fri, August 4th |

| IMPORTANT MATERIAL HANDLING DATES | |
|--|----------------------------|
| | Mark your Calendar |
| Shipments can start arriving at Advance Warehouse | Fri, July 7 th |
| Last Day for Shipment to arrive at warehouse w/o surcharge | Fri, July 28 th |
| Last day for shipments to arrive at warehouse | Fri, Aug 4 th |
| Shipments can start arriving at Show Site | Sat, Aug 5 th |

| |
|----------------------|
| FREIGHT RATES |
|----------------------|

Rates below include receipt of your freight, delivery to your booth, removal, storage, return empty crates and at the end of the show movement of your freight from the booth to the loading dock and reloading onto the designated truck. Charges for this service will be based on the inbound rate and rounded up to the nearest one hundred weight. A 200lbs minimum per shipment applies. (____ pounds ÷ 100 = ____ Total CWT)

Overtime: In addition to your plan below please fill out plan C if your shipment is moved in and/or out of show site on overtime. (Monday-Friday, before 8:00am and/or after 4:30pm, ALL DAY Saturday, Sunday and Holidays).

| PLAN | DESCRIPTION | RECEIVED AT | RATE PER CWT |
|------------|--|---------------------------------|-----------------------|
| A | Package Shipments Received <i>July 7th – July 28th</i> | Warehouse | \$74.00 |
| A+B | Late Shipment Surcharge <i>After July 28th</i> | Warehouse | Additional 25% |
| C | Overtime in and/or out | WH / SS | Additional 25% |
| D | Special Handling (UPS, Fed-Ex, DHL etc) | WH / SS | Additional 25% |
| E | Special Handling (see material handling information) | WH / SS | Additional 30% |
| F | Package Shipments <i>Scheduled to arrive on Sat, Aug 5th</i> | Show Site | \$76.00 |
| G | Small Package Shipment | Show Site | \$50.00 |
| H | Returned to Warehouse | Prior Arrangements must be made | Call for pricing |
| I | Shrink Wrap + one ½ hour Labor Charge | Per Skid | \$25.00 plus labor |
| J | Banding + one ½ hour Labor Charge | Per Linear Foot | \$1.25 plus labor |
| K | Shipments delivered before scheduled dates | WH / SS | Additional 25% |

| |
|--|
| FREIGHT PAYMENT COMPUTATION – Please include if applicable the surcharges i.e. late, overtime in/and or out, special handling |
|--|

| | SELECT PLANS (A-J) | # OF PIECES | WEIGHT MIN 200lbs | RATE/CWT | TOTAL |
|------------|--------------------|-------------|-------------------|----------|-------|
| Shipment 1 | | | | | |
| Shipment 2 | | | | | |
| Shipment 3 | | | | | |
| Shipment 4 | | | | | |
| Shipment 5 | | | | | |
| Shipment 6 | | | | | |

**Please take note of
ORDER DEADLINE FOR MATERIAL
HANDLING/SHIPMENTS LISTED ON THIS
FORM.**

THIS FORM MUST BE ACCOMPANIED BY:
CREDIT CARD BILLING CARD AUTHORIZATION or the
THIRD PARTY CREDIT CARD BILLING FORM. ORDERS
WITHOUT PAYMENT CANNOT BE PROCESSED.
SUBMITTAL OF ORDER AFFIRMS THAT YOU UNDERSTAND
THE TERMS & CONDITIONS LISTED ON THE MATERIAL
HANDLING SECTION OF THE EXHIBITOR KIT.

| | |
|--------------------|--|
| Services Subtotal: | |
| Misc | |
| Services Total: | |



1600 33rd Street, Unit 102
 Orlando, Florida 32839
 T. 407.872.2223 F. 407.872.8644
 Email: orders@gobencs.com

exhibitor shipping information

| | |
|---------------------|--|
| Exhibiting Company: | |
| Booth: | |

The following information is requested so that we may plan in advance and arrange for the proper equipment needed to offer the best possible service to you. We understand that your calculation is only an estimate. Invoicing will be done from the actual weight. Adjustments will be made accordingly.

SHIPMENTS WILL BE SENT TO: ADVANCE WAREHOUSE SHOW SITE

INCOMING SHIPMENT

| | | | |
|-----------------------------|---------|-----------------------|---------|
| Shipped from (city) | | | |
| Carrier | | Tracking/Pro # | |
| Shipping date | | Expected arrival date | |
| No. of Pieces | | Estimated weight | |
| Dimensions of largest piece | Height: | Width: | Length: |
| Misc Requirements | | | |

ADDITIONAL INCOMING SHIPMENT (Different location)

| | | | |
|-----------------------------|---------|-----------------------|---------|
| Shipped from (city) | | | |
| Carrier | | Tracking/Pro # | |
| Shipping date | | Expected arrival date | |
| No. of Pieces | | Estimated weight | |
| Dimensions of largest piece | Height: | Width: | Length: |
| Misc Requirements | | | |

OUTGOING SHIPMENTS

The below information is for back up should the on-site exhibitor fail to complete and turn in a bill of lading to Goben CS Personal.

INSTRUCTIONS FOR OUTGOING SHIPMENTS

| | | | |
|-------------------|--|----------------------------------|----------------------------------|
| Ship To (Company) | | <input type="checkbox"/> Prepaid | <input type="checkbox"/> Collect |
| Attention | | | |
| Address | | | |
| City/State/Zip | | | |
| Description | | | |
| No. of pieces | | Total Weight | |
| Outbound Carrier | | Pro #: | |

| ADVANCE WAREHOUSE | | | |
|--|----------------------------|----|--------|
| EXHIBITION MATERIAL FROM | TO EXHIBITING COMPANY NAME | | |
| | | | |
| BOOTH # | SHOW NAME | | |
| | AM Nuclear / UWC | | |
|  Goben Convention Services DNL Logistics c/o UPS Freight 14476 Duval Place West, #501 Jacksonville, FL 32218 (Last warehouse on right)v | | | |
| Number | | OF | PIECES |
| | | | |
| CARRIER | | | |
| | | | |
| * | | | |

MAKE COPIES AND CUT AS NECESSARY - MAKE COPIES AND CUT AS NECESSARY - MAKE COPIES AND CUT AS NECESSARY

| ADVANCE WAREHOUSE | | | |
|---|----------------------------|----|--------|
| EXHIBITION MATERIAL FROM | TO EXHIBITING COMPANY NAME | | |
| | | | |
| BOOTH # | SHOW NAME | | |
| | AM Nuclear / UWC | | |
|  Goben Convention Services DNL Logistics c/o UPS Freight 14476 Duval Place West, #501 Jacksonville, FL 32218 (Last warehouse on right) | | | |
| Number | | OF | PIECES |
| | | | |
| CARRIER | | | |
| | | | |
| * | | | |

- SHOW SITE SHIPPING LABEL -

| SHOW SITE DELIVERY | | | |
|--|----------------------------|----|--------|
| EXHIBITION MATERIAL FROM | TO EXHIBITING COMPANY NAME | | |
| | | | |
| BOOTH # | SHOW NAME | | |
| | AM Nuclear / UWC | | |
|  Amelia Island Plantation C/O Goben Convention Services 39 Beach Lagoon Rd. Amelia Island, FL 32034 | | | |
| Number | | OF | PIECES |
| | | | |
| CARRIER | | | |
| | | | |
| * | | | |

MAKE COPIES AND CUT AS NECESSARY - MAKE COPIES AND CUT AS NECESSARY - MAKE COPIES AND CUT AS NECESSARY

| SHOW SITE DELIVERY | | | |
|--|----------------------------|----|--------|
| EXHIBITION MATERIAL FROM | TO EXHIBITING COMPANY NAME | | |
| | | | |
| BOOTH # | SHOW NAME | | |
| | AM Nuclear / UWC | | |
|  Amelia Island Plantation C/O Goben Convention Services 39 Beach Lagoon Rd. Amelia Island, FL 32034 | | | |
| Number | | OF | PIECES |
| | | | |
| CARRIER | | | |
| | | | |
| * | | | |



1600 33rd Street, Unit 102
 Orlando, Florida 32839
 T. 407.872.2223 F. 407.872.8644
 Email: orders@gobencs.com

move out information

On behalf of Goben Convention Services we would like to thank you for letting us assist you during the show. We hope the following information will help assist and expedite your move-out.

EXHIBITOR MOVE-OUT START TIME and CLEAN/CLEAR TIME

| Move Out Start Date | Move Out Start Time |
|--------------------------|---------------------|
| Wed, Aug 9 th | 9:00am |

Please note, any exhibitor who chooses to teardown early without preapproval from show management (any time prior to the designated teardown time) will be subject to penalties. Penalties include: priority point(s) deduction and/or fine.

ALL EXHIBITORS MUST BE OFF THE FLOOR BY

| | | |
|--|--------------------------------|--|
| | 1:00pm | |
| | Wed, Aug 9th | |

NO EXCEPTIONS

Beginning the move out time, exhibitors may begin to dismantle their booths. All empty containers will automatically be returned to booths. Please keep all aisles clear to enable Goben Convention Services to complete this process in an expeditious manner. If you have ordered labor to dismantle your booth, be sure to confirm the start time of your works by checking in with the Goben Convention Services; Service Desk.

DRIVER CHECK-IN & BILLS OF LADING DEADLINES

| Driver Check In Date | Driver Check In Time |
|--------------------------|----------------------|
| Wed, Aug 9 th | 12 noon |

It is the exhibitor's responsibility to arrange outbound shipments with their designated carrier (If other than UPS Freight).

| | Re-Route Time |
|--------------------------|---------------|
| Wed, Aug 9 th | 12:01pm |

Schedule your carrier to pick up your freight, directly from the exhibit hall. Your freight carrier MUST be checked in at the Goben Convention Services freight dock no later than the driver check in time and bills of lading deadlines listed on this sheet and in the exhibitor manual to guarantee pick-up. In the event that your designated carrier fails to check in, pick up, refuses acceptance or freight disposition is not provided, Goben Convention Services reserves the right to force/re-route such shipments. Exhibitors will be charged accordingly for this service. No liability will be assumed by show management, Goben Convention Services or any subcontractors as a result of such re-routing or handling.

BILLS OF LADING DUE TO GOBEN CONVENTION SERVICES DESK BY

| | | |
|--|--------------------------------|--|
| | 1:00pm | |
| | Wed, Aug 9th | |

A bill of lading must accompany ALL outbound shipments. Exhibit personnel MUST prepare the outbound bill of lading & make sure each piece of freight is labeled with the destination address prior to departing the show. This form may be obtained at the Goben Convention Services Service Desk. All bills of lading must be turned into the services desk when all your shipments are packed, labeled and ready to ship. Failure to complete and turn in a bill of lading will result in a half hour labor charge.



UPS Freight is the designated show carrier and a representative will be located at the Goben CS Service Desk.

Goben CS will not be responsible for literature/product not properly packed and labeled by exhibit personnel.

DO NOT LEAVE BILLS OF LADING IN YOUR BOOTH!



Trade show shipping made easier for you.



Your booth is the centerpiece of your company's trade show presence. If it doesn't arrive intact and on time, your business could miss out on a golden opportunity to gain exposure within the industry.

At UPS Freight®, we understand your trade show needs, and we're here to make your trade show shipping experience easier than ever.

Whether your booth is headed for the advanced warehouse or direct to the show site, the UPS Freight Trade Show Services Team can provide you with dependable transit times at the right price — ensuring that your trade show experience goes off without a hitch.

UPS Freight® Trade Show Services Team

UPS Freight has established special inbound and outbound rates to and from trade show sites on these services:

- LTL (less-than-truckload) freight shipping
- Truckload shipping
- Expedited shipping
- Specialized carriers (flatbeds, pad-wrapped, air freight, air-ride)

Contact us

Ready to take the next step?
Contact us today by phone at
800.988.9889 or via email at
upsfreighttradeshow@ups.com
to get started!



UPS Freight® Trade Show Services Outbound Shipping

UPS Freight, the official trade show carrier, is providing the following outbound shipping service. If you have any questions or need assistance, please call our Trade Show Services Team at 1 (800) 988-9889 today!

Don't wait! Complete this form and bring it back to the UPS Freight representative at the service desk **the day before** the show closes!

Instructions

1. Prior to the end of the show, pick up a Bill of Lading form, shipping labels and Small Shipment Description form from the exhibitor service desk. Shipments going to multiple destinations require a separate Bill of Lading for each shipment.
2. While at the trade show, see the UPS Freight representative to make arrangements to use the Fast Track shipping process available by using the Official Show Carrier.
3. At the close of the show, apply shipping labels to each piece and leave all freight pieces in your booth area.
4. Complete the Bill of Lading, particularly the "Address" portion and all shaded fields. Note UPS Freight as your carrier and indicate the delivery date needed.
5. After completing the Bill of Lading, return it to the exhibitor service desk before departing from show site.

Outbound Shipping Service Form

The following services are available. Please check the appropriate box.

Truck/Ground Service: 2-5 day service

Air Freight/Expedited Service: Guaranteed service for time-critical shipments.

Order information

Booth #: Company Name: Card Type (circle one): AmEx Visa MasterCard

*For your convenience, we will use this authorization to charge your credit card account for shipping and any additional charges that may occur in handling your shipment as required by your Trade Show Representative. I certify that I have read and agree with the above statement. Initial here:

Cardholder Name: Cardholder Phone:

Credit Card Number: Expiration Date: CVV:

Credit Card Billing Address:

City: State: Zip Code:

Signature:

* By signing above, you agree to the terms and conditions as described on this payment form.

For UPS Freight use only:

PRO# for this shipment: _____ Date of PRO: ___/___/___

Name of Show: _____ Authorized Signature: _____

Charge Amount: _____ Date of Transaction: ___/___/___

Exhibitor Price Guide

EXHIBITOR CONTRACT

Client/Exhibitor Information

Group/Organization: _____ Event: _____
 On-Site Contact _____ Requested by _____
 On-Site Cell # _____ Phone # _____
 Fax # _____ Fax # _____
 E-mail Address _____ E-mail Address _____
 Address _____ City _____ State _____ Zip _____

Service Request

BOOTH/NAME:

| | | | | | |
|-------------|--|--|--|--|--|
| DATES: | | | | | |
| START TIME: | | | | | |
| END TIME: | | | | | |

Note: All computers are required to receive a DHCP assigned IP address passing through NAT from the Omni/Encore network unless other arrangements have been discussed and agreed upon with Encore Event Technologies.

Cost Worksheet

| ITEM | DAILY RATE | QUANTITY | DAYS | TOTAL |
|--------------------------------|---------------------|----------|------|-------|
| Wired High Speed Internet Line | \$150.00 per device | | | |
| Wireless Internet Access | 39.95 per device | | | |
| Additional Internet Line | 75.00 per device | | | |
| Polycom Phone | 140.00 per line | | | |

Customer provided wireless access points or other network infrastructure devices are prohibited to ensure uninterrupted operation of existing hotel wireless infrastructure. Customer provided routers; switches and other networking infrastructure devices are prohibited as to ensure uninterrupted and unimpaired operation of existing hotel network services. Please contact your sales manager for available options.

SUBTOTAL: _____

Service Charge = 24% of Subtotal: _____

City Tax = 7% of Service Charge: _____

GRAND TOTAL: _____

Payment Information

Master Account #: _____ Authorized Signer's Name: _____
 Room # _____ Name on Reservation: _____ Conformation#: _____
 Credit Card #: _____ CCID: _____ Type: _____ Exp: _____
 Customer Signature _____ Print Name _____ Date _____
(as it appears on credit card)

RENTAL CONTRACT MUST BE COMPLETE FOR ORDER TO BE PROCESSED.

Exhibitor Price Guide

EXHIBITOR CONTRACT

Client/Exhibitor Information

Group/Organization: _____ Event: _____
 On-Site Contact _____ Requested by _____
 On-Site Cell # _____ Phone # _____
 Fax # _____ Fax # _____
 E-mail Address _____ E-mail Address _____
 Address _____ City _____ State _____ Zip _____

Exhibitor must be present to sign for order at time of delivery. Please contract the Audio Visual Service Department for delivery. You must notify our representative that you are at your booth and have electrical power in place. We will contract the Electricians for your delivery. Encore Event Technologies is unable to guarantee a delivery time. Exhibitor is responsible for equipment until it is picked up by an Encore Event Technologies representative. Pick up will be at close of show unless otherwise specified. No removal of equipment will take place during show hours.

Payment Information

IF YOU CLAIM SALES TAX EXEMPTION IN THIS STATE, PLEASE FURNISH A COPY OF YOUR TAX-EXEMPT CERTIFICATE WITH YOUR ORDER.

Please indicate method of payment. This section must be completed before your order can be processed. A credit authorization is requested as a deposit against additional services and/or labor. Payment of any balances may also be made by company check upon presentation of statement while at the show, but a credit card authorization should be on file. Any balances outstanding as of move-out will be charged to your account. Please do not ask us to bill you.

Master Account #: _____ Authorized Signer's Name: _____

Credit Card #: _____ CCID: _____ Type: _____ Exp: _____

Customer Signature _____ Print Name _____ Date _____
(as it appears on credit card)

Terms and Conditions

ALL ORDERS SUBJECT TO LIMITS OF LIABILITY AND RESPONSIBILITY AS SET FORTH BELOW.

By executing this order form, Lessee agrees as follows:

1. All checks must be received 72 hours prior to event.

2. Cancellation: In the event Lessee cancels this order, Lessee will be charged a cancellation fee equal to 10% of one day's rental of the subject equipment. Cancellation made within 48 hours of the delivery date will be charged a cancellation fee equal to one day's rental plus handling charges.

3. Risk of Loss: Equipment rental is the responsibility of Lessee. Any equipment which is lost, damaged, or stolen while in Lessee's care or possession will result in Lessee being charged for replacement cost, labor, or parts for repair, as the case may be.

4. Rentals in the City of Amelia Island are subject to city tax of 7%.

5. Insurance for the subject equipment is Lessee's responsibility.

6. On location set-up and take-down by required union labor is not included in the equipment rental price. This fee will be charged by Encore Exhibitor Services. If there are any questions with regards to this charge contact Freeman Exhibitor Services at 904-277-5982

I understand the above condition.

Authorized Signature: _____ Please Type or Print Name: _____

7. Payment tendered for the specified equipment with this reservation form is an estimate only and any changes in equipment requirements and any labor charges will affect this estimate. Lessee is responsible for all charges.

8. It is the responsibility of the exhibitor to advise an Encore Event Technologies representative of any problems with their order at show site. Absolutely no credits will be issued after show closing.

9. Encore Event Technologies must supply all Switches and Hubs for the high-speed Internet service.

I understand the above condition.

Authorized Signature: _____ Please Type or Print Name: _____ Date _____

RENTAL CONTRACT MUST BE COMPLETE FOR ORDER TO BE PROCESSED.

Exhibitor Price Guide

****Please note, (1) 10 Amp connection will be provided, complimentary to UWC exhibitors that request it below. For any electrical support above the 10 Amp powerstrip, pricing is below. Please note, should Encore assess your electrical needs are higher than what you have ordered, you will be charged accordingly.**

Electrical Support

| ITEM | DAILY RATE | QUANTITY | DAYS | TOTAL |
|--|------------|----------|------|-------|
| 20 Amps | \$75.00 | | | |
| 60 Amps | 130.00 | | | |
| 100 Amps | 195.00 | | | |
| 300 Amps | 250.00 | | | |
| Powerstrips <i>** (1) 10 Amp connection is complimentary</i> | 25.00 | | | |

SUBTOTAL: _____

Service Charge = 24% of Subtotal: _____

City Tax = 7% of Service Charge: _____

RENTAL CONTRACT MUST BE COMPLETE FOR ORDER TO BE PROCESSED. GRAND TOTAL: _____